

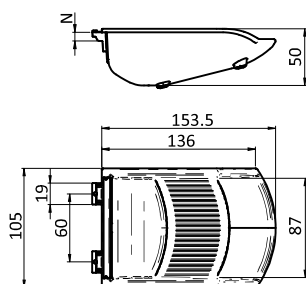

### GREIFSCHALE 105 × 130 × 50 (SET)

### GRAB TRAY 105 × 130 × 50 (SET)

<b>Ausführung</b>	Nut 8, 10	<b>Model</b>	Slot 8, 10
<b>Beschreibung</b>	zur Bereitstellung von Kleinteilen auf Vereinzelfläche und selektiver Aufnahme kleinster Komponenten; durch einfaches Einschwenken in die Profilnut montierbar; gut sichtbares Kennzeichnungsfeld erlaubt eine sichere Zuordnung	<b>Description</b>	To provide hardware and small parts on sorting area for selective grabbing of smallest components; simple assembly by swiveling into the profile slot; the clearly visible label area enables secure part identification
<b>Material</b>	Greifschale Standard-Ausführung: Kunststoff PA, glasfaserverstärkt Greifschale  elektrostatisch entladende Ausführung: Kunststoff PA, kohlefaserverstärkt Sichtfenster: Kunststoff PC Etikett: Karton 250 g/m <sup>2</sup> Elastikpuffer: Kunststoff PU, ≈ 65-70 Shore A	<b>Material</b>	Grab tray standard version: Plastic PA, glass fiber reinforced Grab tray  electrostatically discharging version: Plastic PA, carbon fiber reinforced Label window: Plastic PC Label: Carton 250 g/m <sup>2</sup> Bumper: Plastic PU, ≈ 65-70 Shore A
<b>Set</b>	1 Greifschale, 1 Sichtfenster, 1 Etikett, 4 Elastikpuffer, selbstklebend	<b>Set</b>	1 grab tray, 1 label window, 1 label, 4 bumper, self-adhesive
<b>Liefereinheit</b>	10 Stück	<b>Pack Quantity</b>	10 pieces
<b>Extras</b>	weitere Farben auf Anfrage	<b>Specials</b>	Other colors on request



Greifschale 105 × 130 × 50 (Set) Grab Tray 105 × 130 × 50 (Set)	N	Farbe	Gewicht [g] Weight [g]	Teil-Nr. Part #
	8	schwarz <i>Black</i>	120.1	<b>061MGT2D391N08</b>
elektrostatisch entladend <i>electrostatically discharging</i>	8	schwarz <i>Black</i>	102.4	<b>061MGT2D391N08ESD</b>
	8	gelb ≈ RAL 1003 <i>Yellow</i>	120.1	<b>061MGT2D311N08</b>
	8	rot ≈ RAL 3020 <i>Red</i>	120.1	<b>061MGT2D331N08</b>
	8	grün ≈ RAL 6032 <i>Green</i>	120.1	<b>061MGT2D361N08</b>
	8	grau ≈ RAL 7042 <i>Gray</i>	120.1	<b>061MGT2D374N08</b>
	10	schwarz <i>Black</i>	120.7	<b>061MGT2D391N10</b>
elektrostatisch entladend <i>electrostatically discharging</i>	10	schwarz <i>Black</i>	106.1	<b>061MGT2D391N10ESD</b>
	10	gelb ≈ RAL 1003 <i>Yellow</i>	120.7	<b>061MGT2D311N10</b>
	10	rot ≈ RAL 3020 <i>Red</i>	120.7	<b>061MGT2D331N10</b>
	10	grün ≈ RAL 6032 <i>Green</i>	120.7	<b>061MGT2D361N10</b>
	10	grau ≈ RAL 7042 <i>Gray</i>	120.7	<b>061MGT2D374N10</b>

**GREIFSCHALE 105 × 130 × 50 (SET)**

**GRAB TRAY 105 × 130 × 50 (SET)**

<b>Ausführung</b>	für Einhängeprofil	<b>Model</b>	For suspension profile
<b>Beschreibung</b>	zur Bereitstellung von Kleinteilen auf Vereinzelungsfläche und selektiven Aufnahme kleinster Komponenten; an Einhängeprofil montierbar, durch Einhacken auch in Lochplatten montierbar; gut sichtbares Kennzeichnungsfeld erlaubt eine sichere Zuordnung	<b>Description</b>	To provide hardware and small parts on sorting area for selective grabbing of smallest components; simple assembly by swiveling into the suspension profile or grid plate; the clearly visible label area enables secure part identification
<b>Material</b>	Standard-Ausführung: Kunststoff PA, glasfaserverstärkt ⚡ elektrostatisch entladende Ausführung: Kunststoff PA, kohlefaserverstärkt	<b>Material</b>	Standard version: Plastic PA, glass fiber reinforced ⚡ electrostatically discharging version: Plastic PA, carbon fiber reinforced
<b>Set</b>	1 Greifschale, 1 Sichtfenster, 1 Etikett, 4 Elastikpuffer, selbstklebend	<b>Set</b>	1 grab tray, 1 label window, 1 label, 4 bumper, self-adhesive
<b>Liefereinheit</b>	10 Stück	<b>Pack Quantity</b>	10 pieces
<b>Extras</b>	weitere Farben auf Anfrage	<b>Specials</b>	Other colors on request

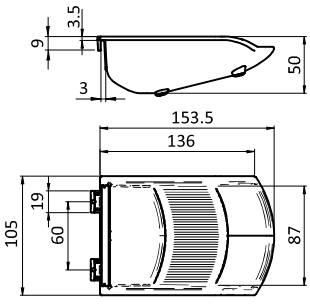

Greifschale 105 × 130 × 50 (Set) Grab Tray 105 × 130 × 50 (Set)	Farbe	Gewicht [g] Weight [g]	Teil-Nr. Part #
	schwarz <i>Black</i>	118.5	<b>061MGT2D391H</b>
elektrostatisch entladend ⚡ <i>electrostatically discharging</i>	schwarz <i>Black</i>	97.4	<b>061MGT2D391HESD</b>
	gelb ≈ RAL 1003 <i>Yellow</i>	118.5	<b>061MGT2D311H</b>
	rot ≈ RAL 3020 <i>Red</i>	118.5	<b>061MGT2D331H</b>
	grün ≈ RAL 6032 <i>Green</i>	118.5	<b>061MGT2D361H</b>
	grau ≈ RAL 7042 <i>gray</i>	118.5	<b>061MGT2D374H</b>

6



**GREIFBEHÄLTER 110 / 210 × 105 × 40**

**GRAB CONTAINER 110 / 210 × 105 × 40**

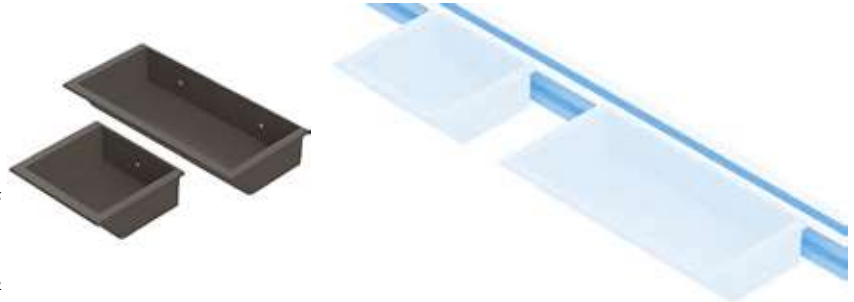
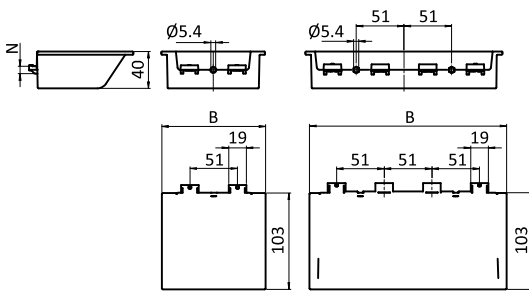

<b>Ausführung</b>	Nut 8, 10	<b>Model</b>	Slot 8, 10
<b>Beschreibung</b>	zur Bereitstellung von bevorrateten Kleinteilen; durch einfaches Einschwenken in die Profilnut montierbar, optionale Fixiermöglichkeit mittels 1 oder 2 Schrauben M5	<b>Description</b>	To store and provide small parts; simple assembly by swiveling into the profile slot, optional fixation possibility using 1 or 2 screws M5
<b>Material</b>	Kunststoff PA, glasfaserverstärkt	<b>Material</b>	Plastic PA, glass fiber reinforced
<b>Farbe</b>	schwarz	<b>Color</b>	Black
<b>Liefereinheit</b>	10 Stück	<b>Pack Quantity</b>	10 pieces
<b>Extras</b>	weitere Farben auf Anfrage	<b>Specials</b>	Other colors on request





Greifbehälter 110 / 210 × 105 × 40 Grab Container 110 / 210 × 105 × 40	B [mm]	N	Gewicht [g] Weight [g]	Profil Profile	Teil-Nr. Part #
	110	8	95.2	I	<b>061MGC2D291N08</b>
	110	10	97.2	B	<b>061MGC2D291N10</b>
	210	8	190.8	I	<b>061MGC4D291N08</b>
	210	10	194.1	B	<b>061MGC4D291N10</b>

**GREIFBEHÄLTER 110 × 210 × 40 (SET)**

**GRAB CONTAINER 110 × 210 × 40 (SET)**

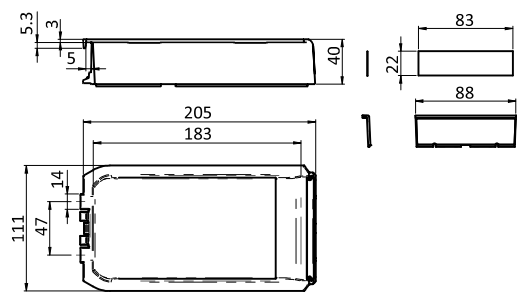
<p><b>Ausführung</b> für Einhängeprofil</p> <p><b>Beschreibung</b> zur Bereitstellung von bevorrateten Kleinteilen; an Einhängeprofil montierbar, mit optionalem Adapter auch schwenkbar in der Profilvernuth montierbar; gut sichtbares Kennzeichnungsfeld erlaubt eine sichere Zuordnung; stapelbar</p> <p><b>Material</b> Greifbehälter Standard-Ausführung: Kunststoff PA, glasfaserverstärkt Greifbehälter  elektrostatisch entladende Ausführung: Kunststoff PA, kohlefaserverstärkt Sichtfenster: Kunststoff PC Etikett: Karton 250 g/m<sup>2</sup></p> <p><b>Farbe</b> Greifbehälter: schwarz Sichtfenster: transparent</p> <p><b>Set</b> 1 Greifbehälter, 1 Sichtfenster, 1 Etikett</p> <p><b>Liefereinheit</b> 10 Stück</p> <p><b>Extras</b> weitere Farben auf Anfrage</p> <p><b>Hinweis</b> passender Schwenkadapter für Profilvernuth siehe Seite 572</p>	<p><b>Model</b> For suspension profile</p> <p><b>Description</b> To store and provide small parts; simple assembly by swiveling into the suspension profile, optional adapter allows for horizontally pivoting fixation; the clearly visible label area enables secure part identification; stackable</p> <p><b>Material</b> Grab container standard version: Plastic PA, glass fiber reinforced Grab container  electrostatically discharging version: Plastic PA, carbon fiber reinforced Label window: Plastic PC Label: Carton 250 g/m<sup>2</sup></p> <p><b>Color</b> Grab container: Black Label window: Transparent</p> <p><b>Set</b> 1 grab container, 1 label window, 1 label</p> <p><b>Pack Quantity</b> 10 pieces</p> <p><b>Specials</b> Other colors on request</p> <p><b>Tip</b> Compatible swivel adapter for profile slot see page 572</p>
---	--





<p>Greifbehälter 110 × 210 × 40 (Set) Grab Container 110 × 210 × 40 (Set)</p>	<p>Gewicht [g] Weight [g]</p>	<p>Teil-Nr. Part #</p>
<p>elektrostatisch entladend  electrostatically discharging</p>	<p>175.5</p>	<p><b>061MGC2K291H</b></p>
	<p>150.0</p>	<p><b>061MGC2K291HESD</b></p>

6

**SCHALENBEHÄLTER 110 × 270 × 40 (SET)**

**TRAY CONTAINER 110 × 270 × 40 (SET)**

<p><b>Ausführung</b> für Einhängeprofil</p> <p><b>Beschreibung</b> zur Bereitstellung von bevorrateten Kleinteilen mit Vereinzelungsfläche; an Einhängeprofil montierbar, mit optionalem Adapter auch waagrecht schwenkbar in der Profilmutter montierbar; gut sichtbares Kennzeichnungsfeld erlaubt eine sichere Zuordnung; stapelbar</p> <p><b>Material</b> Schalenbehälter Standard-Ausführung: Kunststoff PA, glasfaserverstärkt Schalenbehälter  elektrostatisch entladende Ausführung: Kunststoff PA, kohlefaserverstärkt Sichtfenster: Kunststoff PC Etikett: Karton 250 g/m<sup>2</sup></p> <p><b>Farbe</b> Schalenbehälter: schwarz Sichtfenster: transparent</p> <p><b>Set</b> 1 Schalenbehälter, 1 Sichtfenster, 1 Etikett</p> <p><b>Liefereinheit</b> 10 Stück</p> <p><b>Extras</b> weitere Farben auf Anfrage</p> <p><b>Hinweis</b> passender Schwenkadapter für Profilmutter siehe Seite 572</p>	<p><b>Model</b> For suspension profile</p> <p><b>Description</b> To store and provide small parts, with sorting area; simple assembly by swiveling into the suspension profile, optional adapter allows for horizontally pivoting fixation; the clearly visible label area enables secure parte identification; stackable</p> <p><b>Material</b> Tray container standard version: Plastic PA, glass fiber reinforced Tray container  electrostatically discharging version: Plastic PA, carbon fiber reinforced Label window: Plastic PC Label: Carton 250 g/m<sup>2</sup></p> <p><b>Color</b> Tray container: Black Label window: Transparent</p> <p><b>Set</b> 1 tray container, 1 label window, 1 label</p> <p><b>Pack Quantity</b> 10 pieces</p> <p><b>Specials</b> Other colors on request</p> <p><b>Tip</b> Compatible swivel adapter for profile slot see page 572</p>
---	--

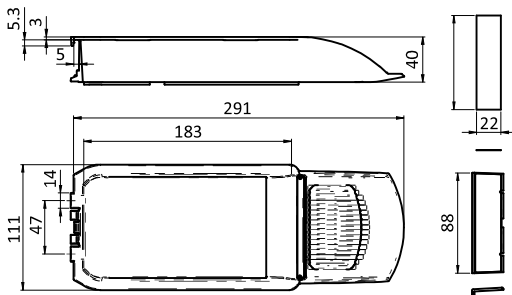

Schalenbehälter 110 × 270 × 40 (Set)  
Tray Container 110 × 270 × 40 (Set)

Gewicht [g]  
Weight [g]

Teil-Nr.  
Part #

	219.3	061MTC2K291H
elektrostatisch entladend  electrostatically discharging	186.7	061MTC2K291HESD



## SCHWENKADAPTER FÜR BEHÄLTER

## PIVOTING ADAPTER FOR CONTAINERS

<p><b>Ausführung</b> Nut 8, 10, für Greifbehälter 110 × 210 × 40 und Schalenbehälter 110 × 270 × 40</p> <p><b>Beschreibung</b> zur Befestigung von Greif- und Schalenbehälter an Profilnuten, mit separaten Nutfixierungen Nut 8 und Nut 10; schwenkbar in beide Richtungen bis zu 45°, Schwenkbereich waagrecht verstellbar indem Feststellschraube gelöst wird</p> <p><b>Material</b> Gehäuse Standard-Ausführung: Kunststoff PA, glasfaserverstärkt Gehäuse  elektrostatisch entladende Ausführung: Kunststoff PA, kohlefaserverstärkt Adapter Standard-Ausführung: Kunststoff PA, glaskugelverstärkt Adapter  elektrostatisch entladende Ausführung: Kunststoff PA, kohlefaserverstärkt Fixierung: Zinkdruckguss Befestigungsmaterial: Stahl</p> <p><b>Farbe</b> Gehäuse: schwarz Adapter: schwarz</p> <p><b>Liefereinheit</b> 10 Stück</p> <p><b>Extras</b> weitere Farben auf Anfrage</p> <p><b>Hinweis</b> passender Greifbehälter siehe Seite 570; passender Schalenbehälter siehe Seite 571</p>	<p><b>Model</b> Slot 8, 10, for grab containers 110 × 210 × 40 and tray containers 110 × 270 × 40</p> <p><b>Description</b> To fix grab containers and grab trays on profile slots; with separate slot fixing for slot 8 and slot 10; pivotable in two directions up to 45°; with locking screw for enabling or disabling horizontal pivoting</p> <p><b>Material</b> Housing standard version: Plastic PA, glass fiber reinforced Housing  electrostatically discharging version: Plastic PA, carbon fiber reinforced Adapter standard version: Plastic PA, glass ball reinforced Adapter  electrostatically discharging version: Plastic PA, carbon fiber reinforced Centering pieces: Zinc die-cast Mounting material: Steel</p> <p><b>Color</b> Housing: Black Adapter: Black</p> <p><b>Pack Quantity</b> 10 pieces</p> <p><b>Specials</b> Other colors on request</p> <p><b>Tip</b> Compatible Grab Container see page 570; Compatible Tray Container see page 571</p>
--	--

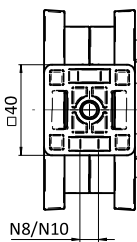
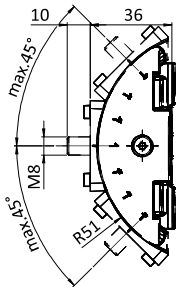

Schwenkadapter für Behälter  
*Pivoting Adapter for containers*

Gewicht [g]  
Weight [g]

Teil-Nr.  
Part #

75.4

061MA2291NS01

elektrostatisch entladend *electrostatically discharging*

64.3

061MA2291NESDS01