

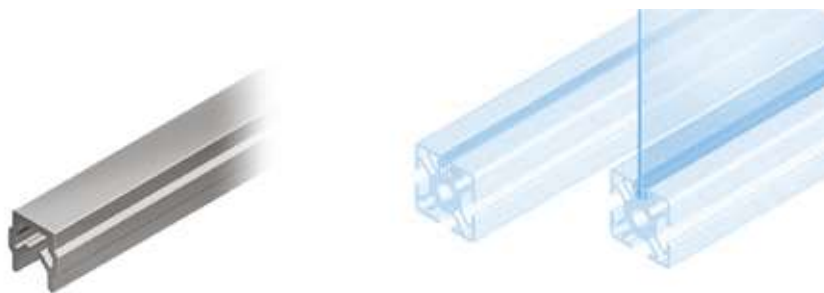

ABDECK- UND EINFASSPROFIL

COVER AND REDUCTION PROFILE

Ausführung	Kunststoff PP, Nut 5	Model	Plastic PP, slot 5
Beschreibung	zum Abdecken von Nuten mit Breite 5 mm und zum Einfassen von Flächenelementen mit 2 - 3 mm	Description	To cover size 5 profile slots and to secure panels with a thickness of 2 - 3 mm
Material	Kunststoff PP	Material	Plastic PP
Farbe	schwarz / natur	Color	Black / natural
Liefereinheit	200 Meter (100 Stück à 2 m)	Pack Quantity	200 meters (100 pieces at 2 m)
Extras	weitere Farben auf Anfrage	Specials	Other colors on request
Hinweis	Bitte beachten: Sie bestellen in Meter!	Tip	Please note: You are ordering in meters!

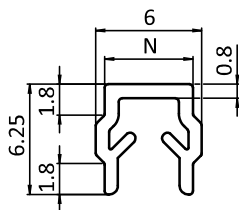

Abdeck- und Einfassprofil <i>Cover and Reduction Profile</i>	Nut <i>Slot</i>	Gewicht [g/m] <i>Weight [g/m]</i>	Profil <i>Profile</i>	Teil-Nr. <i>Part #</i>
schwarz <i>Black</i>	5	26.0	I	092045
natur <i>Natural</i>	5	26.0	I	092047

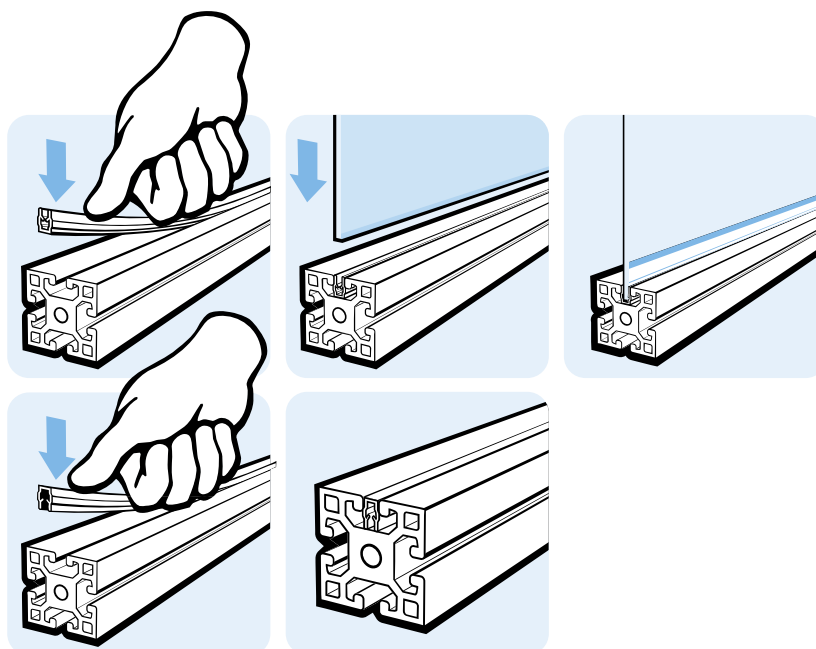



ABDECK- UND EINFASSPROFIL

COVER AND REDUCTION PROFILE

Ausführung	Kunststoff PP, Nut 6	Model	Plastic PP, slot 6
Beschreibung	zum Abdecken von Nuten mit Breite 6 mm und zum Einfassen von Flächenelementen mit 1 - 4 mm	Description	To cover size 6 profile slots and to secure panels with a thickness of 1 - 4 mm
Material	Kunststoff PP	Material	Plastic PP
Farbe	schwarz	Color	Black
Liefereinheit	200 Meter (100 Stück à 2 m)	Pack Quantity	200 meters (100 pieces at 2 m)
Extras	weitere Farben auf Anfrage	Specials	Other colors on request
Hinweis	Bitte beachten: Sie bestellen in Meter!	Tip	Please note: You are ordering in meters!

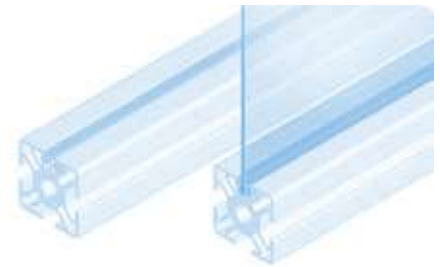
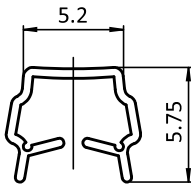

Abdeckprofil <i>Cover Profile</i>	Nut <i>Slot</i>	Gewicht [g/m] <i>Weight [g/m]</i>	Profil <i>Profile</i>	Teil-Nr. <i>Part #</i>
	6	17.0	B	092246

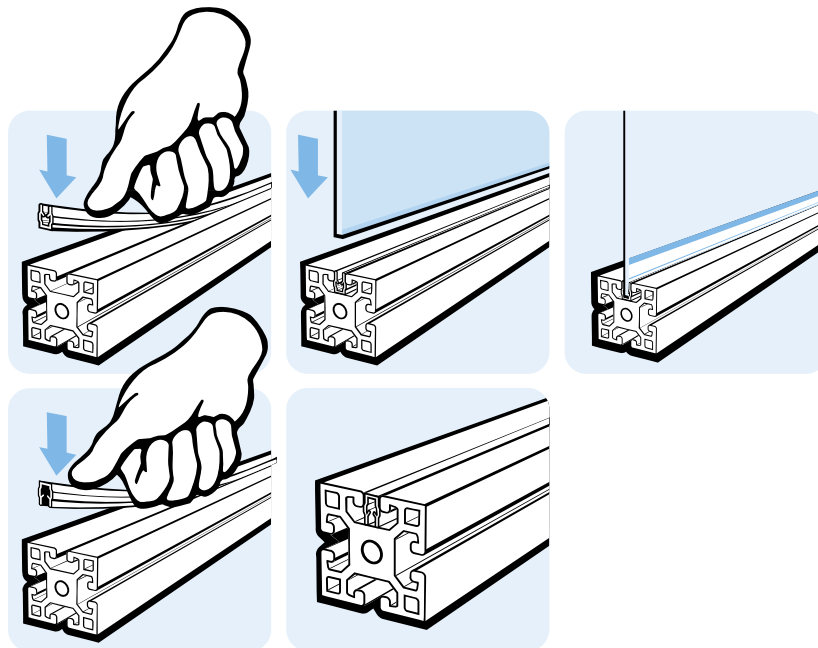



ABDECK- UND EINFASSPROFIL

COVER AND REDUCTION PROFILE

Ausführung	Kunststoff PP, Nut 6	Model	Plastic PP, slot 6
Beschreibung	zum Abdecken von Nuten mit Breite 6 mm und zum Einfassen von Flächenelementen mit 2 - 3,5 mm	Description	To cover size 6 profile slots and to secure panels with a thickness of 2 - 3.5 mm
Material	Kunststoff PP	Material	Plastic PP
Farbe	schwarz / natur / grau	Color	Black / natural / gray
Liefereinheit	200 Meter (100 Stück à 2 m)	Pack Quantity	200 meters (100 pieces at 2 m)
Extras	weitere Farben auf Anfrage	Specials	Other colors on request
Hinweis	Bitte beachten: Sie bestellen in Meter!	Tip	Please note: You are ordering in meters!

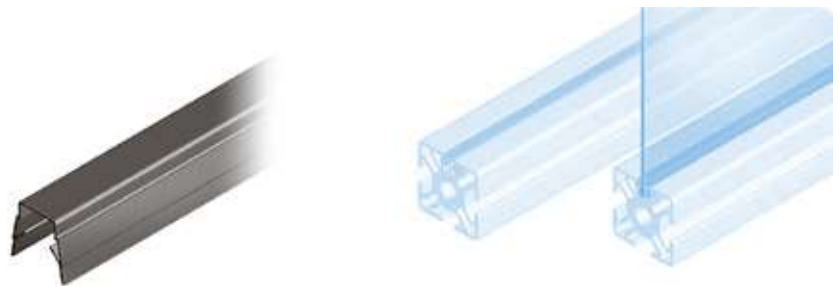
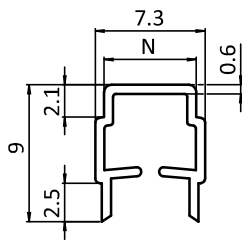

Abdeck- und Einfassprofil <i>Cover and Reduction Profile</i>	Nut Slot	Gewicht [g/m] Weight [g/m]	Profil Profile	Teil-Nr. Part #
schwarz <i>Black</i>	6	26.0	I	092033
natur <i>Natural</i>	6	26.0	I	092034
grau ≈ RAL 7035 <i>Gray</i>	6	26.0	I	092033S01

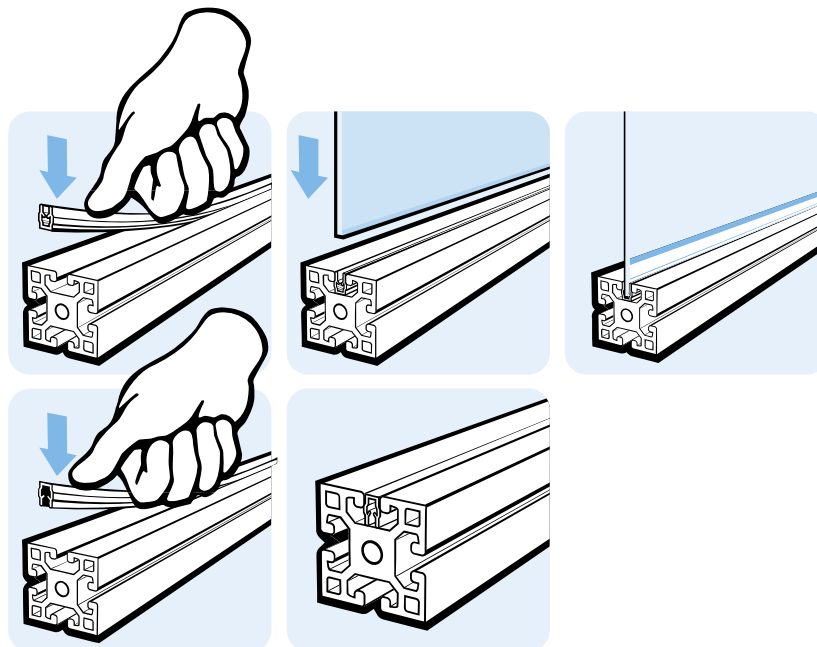



ABDECKPROFIL

COVER PROFILE

Ausführung	Kunststoff PP, Nut 6	Model	Plastic PP, slot 6
Beschreibung	zum Abdecken von Nuten mit Breite 6 mm und Steghöhe 3,0 mm	Description	To cover T-Slots with 6 mm width and a 3.0 mm profile web
Material	Kunststoff PP	Material	Plastic PP
Farbe	schwarz, natur, alufarbig	Color	Black, natural, alu color
Liefereinheit	200 Meter (100 Stück à 2 m)	Pack Quantity	200 meters (100 pieces at 2 m)
Extras	weitere Farben auf Anfrage	Specials	Other colors on request
Hinweis	Bitte beachten: Sie bestellen in Meter!	Tip	Please note: You are ordering in meters!

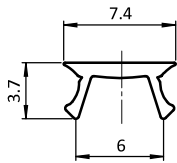

Abdeckprofil <i>Cover Profile</i>	Nut 6 <i>Slot 6</i>	Gewicht [g/m] <i>Weight [g/m]</i>	Profil <i>Profile</i>	Teil-Nr. <i>Part #</i>
schwarz <i>Black</i>	6	11.0	I	092130
natur <i>Natural</i>	6	11.0	I	092130S01
alufarbig geprägt <i>Alu color coated</i>	6	11.0	I	092130A

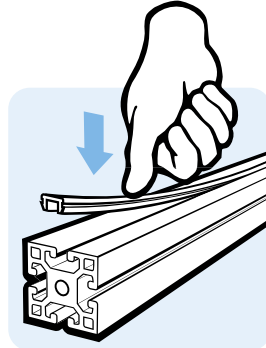



ABDECK- UND EINFASSPROFIL

COVER AND REDUCTION PROFILE

Ausführung	Kunststoff PP, Nut 8	Model	Plastic PP, slot 8
Beschreibung	zum Abdecken von Nuten mit Breite 8 mm und zum Einfassen von Flächenelementen mit 4 - 6 mm	Description	To cover size 8 profile slots and to secure panels with a thickness of 4 - 6 mm
Material	Kunststoff PP	Material	Plastic PP
Farbe	schwarz, natur, grau, rot, blau, gelb, weißaluminium	Color	Black, natural, gray, red, blue, yellow, white aluminum
Liefereinheit	200 Meter (100 Stück à 2 m)	Pack Quantity	200 meters (100 pieces at 2 m)
Extras	weitere Farben auf Anfrage	Specials	Other colors on request
Hinweis	Bitte beachten: Sie bestellen in Meter!	Tip	Please note: You are ordering in meters!

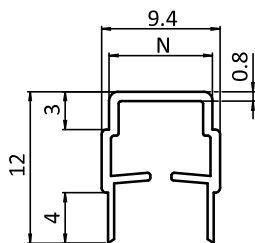

Abdeck- und Einfassprofil <i>Cover and Reduction Profile</i>	Nut <i>Slot</i>	Gewicht [g/m] <i>Weight [g/m]</i>	Profil <i>Profile</i>	Teil-Nr. <i>Part #</i>
schwarz <i>Black</i>	8	26.0	I	092031
natur <i>Natural</i>	8	26.0	I	092030
grau ≈ RAL 7035 <i>Gray</i>	8	26.0	I	092035
rot ≈ RAL 3020 <i>Red</i>	8	26.0	I	092036
blau ≈ RAL 5005 <i>Blue</i>	8	26.0	I	092037
gelb ≈ RAL 1018 <i>Yellow</i>	8	26.0	I	092031S03
weißaluminium ≈ RAL 9006 <i>White aluminum</i>	8	26.0	I	092031S04

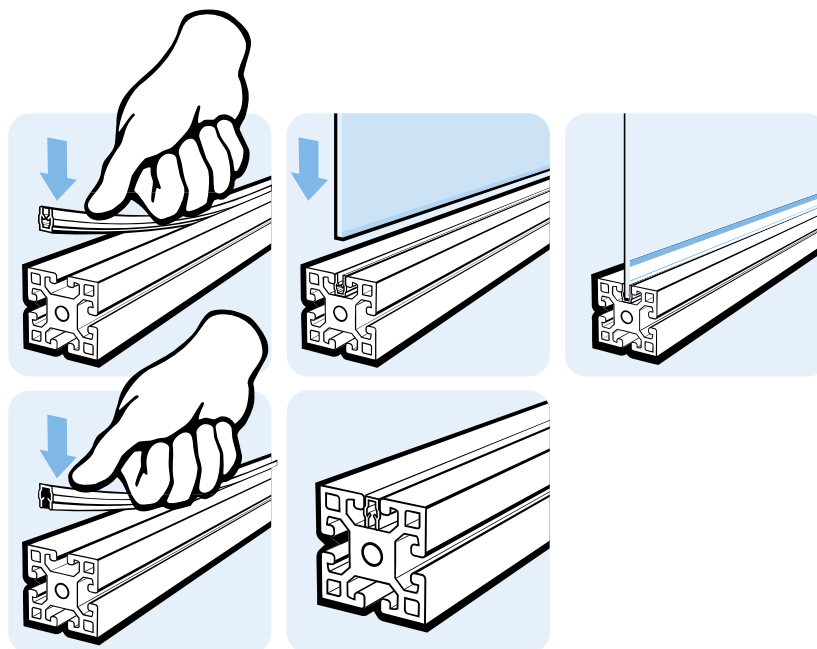



ABDECK- UND EINFASSPROFIL

COVER AND REDUCTION PROFILE

Ausführung	Kunststoff PP + TPE, Nut 8	Model	Plastic PP + TPE, slot 8
Beschreibung	zum Abdecken von Nuten mit Breite 8 mm und zum Einfassen von Flächenelementen mit 4 - 6 mm	Description	To cover size 8 profile slots and to secure panels with a thickness of 4 - 6 mm
Material	Kunststoff PP + TPE	Material	Plastic PP + TPE
Farbe	schwarz	Color	Black
Liefereinheit	200 Meter (100 Stück à 2 m)	Pack Quantity	200 meters (100 pieces at 2 m)
Extras	weitere Farben auf Anfrage	Specials	Other colors on request
Hinweis	Bitte beachten: Sie bestellen in Meter!	Tip	Please note: You are ordering in meters!

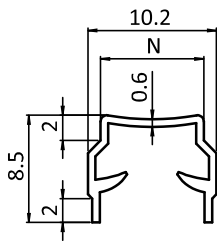

Abdeck- und Einfassprofil <i>Cover and Reduction Profile</i>	Nut Slot	Gewicht [g/m] Weight [g/m]	Profil Profile	Teil-Nr. Part #
	8	25.0	B	092242



ABDECKPROFIL

COVER PROFILE

Ausführung	Kunststoff PP, Nut 8, 10	Model	Plastic PP, slot 8, 10
Beschreibung	zum Abdecken von Nuten mit Breite 8 und 10 mm	Description	To cover size 8 and 10 profile slots
Material	Kunststoff PP	Material	Plastic PP
Farbe	schwarz, gelb, orange, rot, blau, grau, weiß, natur, alufarbig	Color	Black, yellow, orange, red, blue, gray, white, nature, alu color
Liefereinheit	200 Meter (100 St. à 2m)	Pack Quantity	200 meters (100 pieces at 2m)
Extras	weitere Farben auf Anfrage	Specials	Other colors on request
Hinweis	Bitte beachten: Sie bestellen in Meter!	Tip	Please note: You are ordering in meters!

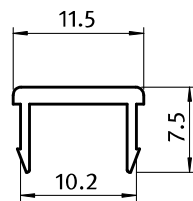
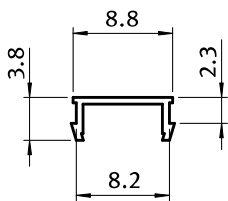

Abdeckprofil Cover Profile	Nut Slot	Gewicht [g/m] Weight [g/m]	Profil Profile	Teil-Nr. Part #
schwarz <i>Black</i>	8	10.0	B	092050
schwarz, ⚡ elektrostatisch entladend <i>Black, ⚡ electrostatically discharging</i>	8	10.0	B	092050S12
gelb ≈ RAL 1018 <i>Yellow</i>	8	10.0	B	092054
rot ≈ RAL 3020 <i>Red</i>	8	10.0	B	092050S07
blau ≈ RAL 5005 <i>Blue</i>	8	10.0	B	092050S04
grau ≈ RAL 7035 <i>Gray</i>	8	10.0	B	092052
natur <i>Natural</i>	8	10.0	B	092050S03
alufarbig geprägt <i>Alu color imprint</i>	8	10.0	B	092050A
alufarbig geprägt, ⚡ elektrostatisch entladend <i>Alu color imprint, ⚡ electrostatically discharging</i>	8	10.0	B	092050AS01
schwarz <i>Black</i>	10	28.1	B	092041
schwarz, ⚡ elektrostatisch entladend <i>Black, ⚡ electrostatically discharging</i>	10	28.1	B	092041S08
gelb ≈ RAL 1018 <i>Yellow</i>	10	28.1	B	092044
gelb ≈ RAL 1023 <i>Yellow</i>	10	28.1	B	092044S01
orange ≈ RAL 2004 <i>Orange</i>	10	28.1	B	092043
rot ≈ RAL 3020 <i>Red</i>	10	28.1	B	092041S03
blau ≈ RAL 5005 <i>Blue</i>	10	28.1	B	092041S06
grau ≈ RAL 7035 <i>Gray</i>	10	28.1	B	092042
weiß ≈ RAL 9003 <i>White</i>	10	28.1	B	092041S05
natur <i>Natural</i>	10	28.1	B	092041S13
alufarbig geprägt <i>Alu color imprint</i>	10	28.1	B	092041A
alufarbig geprägt, ⚡ elektrostatisch entladend <i>Alu color imprint, ⚡ electrostatically discharging</i>	10	28.1	B	092041AS01



ABDECKPROFIL

COVER PROFILE

Ausführung	Kunststoff PP, Nut 8	Model	Plastic PP, slot 8
Beschreibung	zum Abdecken von Nuten mit Breite 8 mm und Steghöhe 4,5 mm	Description	To cover T-Slots with 8 mm width and a 4.5 mm profile web
Material	Kunststoff PP	Material	Plastic PP
Farbe	schwarz, gelb, grau, natur, alufarbig	Color	Black, yellow, gray, natural, alu color
Liefereinheit	200 Meter (100 Stück à 2m)	Pack Quantity	200 meters (100 pieces at 2m)
Extras	weitere Farben auf Anfrage	Specials	Other colors on request
Hinweis	Bitte beachten: Sie bestellen in Meter!	Tip	Please note: You are ordering in meters!

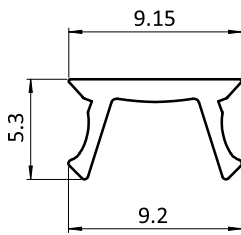

Abdeckprofil <i>Cover Profile</i>	Nut <i>Slot</i>	Gewicht [g/m] <i>Weight [g/m]</i>	Profil <i>Profile</i>	Teil-Nr. <i>Part #</i>
schwarz <i>Black</i>	8	16.0	I	092080
gelb ≈ RAL 1018 <i>Yellow</i>	8	16.0	I	092081
grau ≈ RAL 7035 <i>Gray</i>	8	16.0	I	092085
natur <i>Natural</i>	8	16.0	I	092082
alufarbig geprägt <i>Alu color imprint</i>	8	16.0	I	092080A

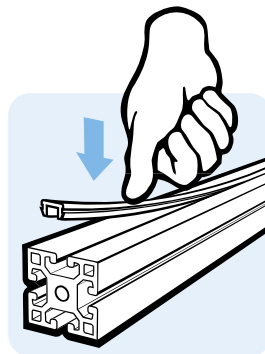



ABDECKPROFIL

COVER PROFILE

Ausführung	Aluminium, Nut 8	Model	Aluminum, slot 8
Beschreibung	zum Abdecken von Nuten mit Breite 8 mm und Steghöhe 4,5 mm	Description	To cover T-Slots with 8 mm width and a 4.5 mm profile web
Material	Aluminium, eloxiert	Material	Aluminum, anodized
Liefereinheit	50 Meter (25 St. à 2m)	Pack Quantity	50 meters (25 pieces at 2m)
Hinweis	Bitte beachten: Sie bestellen in Meter!	Tip	Please note: You are ordering in meters!

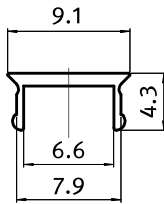

Abdeckprofil <i>Cover Profile</i>	Nut <i>Slot</i>	Gewicht [g/m] <i>Weight [g/m]</i>	Profil <i>Profile</i>	Teil-Nr. <i>Part #</i>
	8	33.0	I	092055

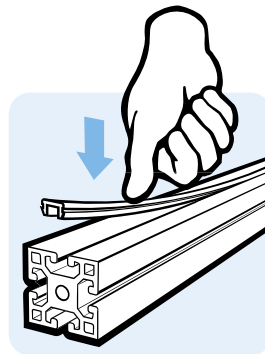



ABDECKPROFIL

COVER PROFILE

Ausführung	Aluminium, Nut 8	Model	Aluminum, slot 8
Beschreibung	zum Abdecken von Nuten mit Breite 8 mm und Steghöhe 4,5 mm	Description	To cover T-Slots with 8 mm width and a 4.5 mm profile web
Material	Aluminium, eloxiert	Material	Aluminum, anodized
Liefereinheit	50 Meter (25 St. à 2m)	Pack Quantity	50 meters (25 pieces at 2m)
Hinweis	Bitte beachten: Sie bestellen in Meter!	Tip	Please note: You are ordering in meters!

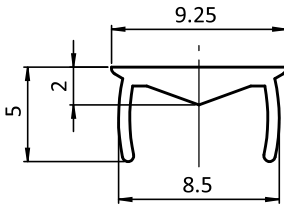

Abdeckprofil <i>Cover Profile</i>	Nut Slot	Gewicht [g/m] <i>Weight [g/m]</i>	Profil Profile	Teil-Nr. <i>Part #</i>
	8	43.0	B	092071

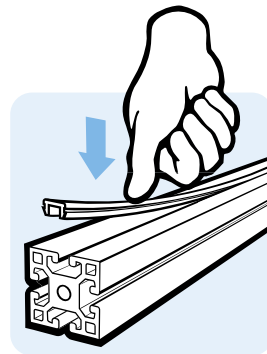



ABDECKPROFIL

COVER PROFILE

Ausführung	Aluminium, Nut 10	Model	Aluminum, slot 10
Beschreibung	zum Abdecken von Nuten mit Breite 10 mm und Steghöhe 6 mm	Description	To cover T-Slots with 10 mm width and a 6 mm profile web
Material	Aluminium, eloxiert	Material	Aluminum, anodized
Liefereinheit	50 Meter (25 St. à 2m)	Pack Quantity	50 meters (25 pieces at 2m)
Hinweis	Bitte beachten: Sie bestellen in Meter!	Tip	Please note: You are ordering in meters!

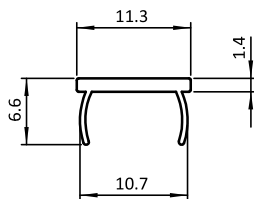

Abdeckprofil <i>Cover Profile</i>	Nut <i>Slot</i>	Gewicht [g/m] <i>Weight [g/m]</i>	Profil <i>Profile</i>	Teil-Nr. <i>Part #</i>
	10	56.5	B	092070

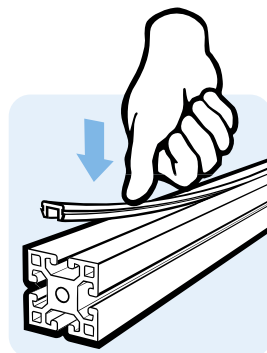



ABDECKPROFIL

COVER PROFILE

Ausführung	Kunststoff NBR, Nut 6, Nut 8	Model	Plastic NBR, slot 6, slot 8
Beschreibung	zum Abdecken von Aluprofilen	Description	To cover aluminum profiles
Material	Kunststoff NBR, ≈80 Shore A	Material	Plastic NBR, ≈80 Shore A
Farbe	schwarz	Color	Black
Liefereinheit	20 Meter (Spule)	Pack Quantity	20 meter (spool)
Hinweis	Bitte beachten: Sie bestellen in Meter!	Tip	Please note: You are ordering in meters!

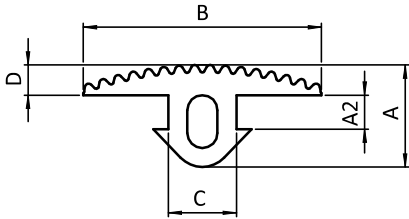

Abdeckprofil <i>Cover Profile</i>	A [mm]	A2 (Profil) [mm] A2 (Profile) [mm]	B [mm]	C [mm]	D [mm]	Nut Slot	Gewicht [g/m] Weight [g/m]	Profil Profile	Teil-Nr. Part #
	11.0	2.5 (3.0)	26.0	6.5	3.0	6	103.0	I	092058
	13.5	4.5 (4.5)	31.5	9	4.0	8	210.0	I	092057

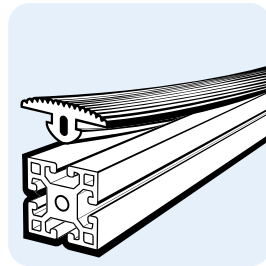



ABDECKKAPPE FÜR RASTERMAß 20 MM

COVER CAP FOR 20 MM MODULAR DIMENSION

Ausführung	Rastermaß 20 mm	Model	20 mm modular dimension
Beschreibung	zum Abdecken der Profilenden	Description	To cover the end of the profile
Material	Kunststoff PA, glasfaserverstärkt	Material	Plastic PA, glass fiber reinforced
Farbe	schwarz	Color	Black
Liefereinheit	100 Stück	Pack Quantity	100 pieces
Extras	☁ elektrostatisch entladend, weitere Größen, weitere Farben auf Anfrage	Specials	☁ electrostatically discharging, other sizes, other colors on request

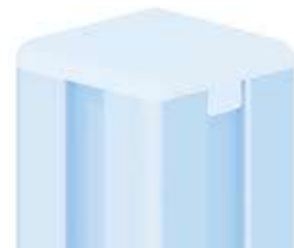
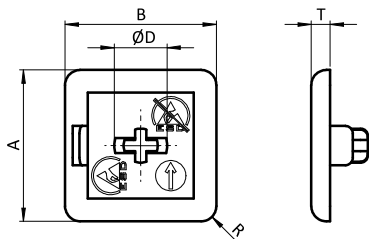

Abdeckkappe Cover Cap	ØD [mm]	R [mm]	T [mm]	Eigenschaft Description	Maße A x B [mm] Dimensions A x B [mm]	Profil Profile	Teil-Nr. Part #
Nut 5 <i>Slot 5</i>	3.4 (3.3)	2.0	3.0	2 Kreuze <i>2 cross</i>	10 x 20	I	091125
	3.4 (3.3)	2.0	2.5	2 Stifte <i>2 pins</i>	10 x 40	I	091236
	4.5 (4.3)	2.5	4.0	1 Kreuz <i>1 cross</i>	20 x 20	I	091043
	4.5 (4.3)	2.0	2.5	neue Ausführung, 1 Stift <i>New version, 1 pin</i>	20 x 20	I	091180
	4.5 (4.3)	2.5	4.0	1 Kreuz <i>1 cross</i>	20 x 40	I	091050
	4.5 (4.3)	2.0	2.5	neue Ausführung, 2 Kreuze <i>New version, 2 cross</i>	20 x 40	I	091181
	4.5 (4.3)	2.0	2.5	3 Kreuze <i>3 cross</i>	20 x 60	I	091183
	4.5 (4.3)	2.0	2.5	4 Kreuze <i>4 cross</i>	40 x 40	I	091182
Nut 6 <i>Slot 6</i>	5.4 (5.5)	2.5	4.0	1 Kreuz <i>1 cross</i>	20 x 20	B	091042
	5.7 (5.5)	1.5	2.5	neue Ausführung, 1 Kreuz <i>New version, 1 cross</i>	20 x 20	B	091332



ABDECKKAPPE FÜR RASTERMAß 30 MM

COVER CAP FOR 30 MM MODULAR DIMENSION

Ausführung	Rastermaß 30 mm	Model	30 mm modular dimension
Beschreibung	zum Abdecken der Profilenenden	Description	To cover the end of the profile
Material	Kunststoff PA, glasfaserverstärkt	Material	Plastic PA, glass fiber reinforced
Farbe	schwarz	Color	Black
Liefereinheit	100 Stück	Pack Quantity	100 pieces
Extras	☁ elektrostatisch entladend, weitere Größen, weitere Farben auf Anfrage	Specials	☁ electrostatically discharging, other sizes, other colors on request

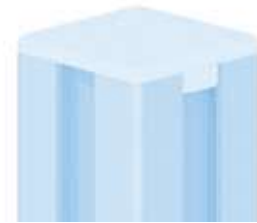
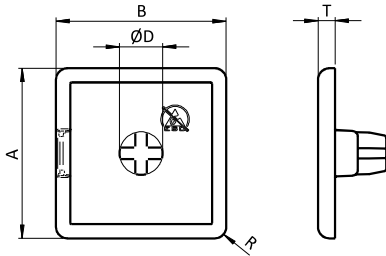

Abdeckkappe <i>Cover Cap</i>	ØD [mm]	R [mm]	T [mm]	Eigenschaft <i>Description</i>	Maße A x B [mm] <i>Dimensions A x B [mm]</i>	Profil <i>Profile</i>	Teil-Nr. <i>Part #</i>
Nut 6 <i>Slot 6</i>	5.2 (5.0)	3.0	3.0	4 Kreuze <i>4 cross</i>	30 x 120	I	091187
	5.2 (5.0)	3.0	3.0	1 Kreuz <i>1 cross</i>	30 x 30	I	091184
	5.2 (5.0)	3.0	3.0	1 Kreuz <i>1 cross</i>	30 x 30 45°	I	091188
	5.2 (5.0)	3.0	3.0	1 Kreuz <i>1 cross</i>	30 x 30 R30 - 90°	I	091245
	6.9 (7.3)	3.0	4.0	2 Kreuze <i>2 cross</i>	30 x 60	I	091141
	5.2 (5.0)	3.0	3.0	neue Ausführung, 2 Kreuze <i>New version, 2 cross</i>	30 x 60	I	091185
	5.2 (5.0)	3.0	3.0	4 Kreuze <i>4 cross</i>	60 x 60	I	091186
Nut 8 <i>Slot 8</i>	3.3	2.0	3.0	3 Stifte <i>3 pins</i>	11 x 20	B	091346
	7.6 (7.3)	3.0	4.0	1 Kreuz <i>1 cross</i>	30 x 30	B	091027
	10.8 (10.0)	3.0	4.0	neue Ausführung 1, 1 Kreuz gedreht 45° <i>New version 1, 1 cross turned 45°</i>	30 x 30	B	091252
	7.6 (7.3)	2.0	3.0	neue Ausführung 2, 1 Kreuz <i>New version 2, 1 cross</i>	30 x 30	B	091371
	4.0	2.0	3.0	mit Loch Ø 8.5 mm, 4 Stifte <i>With hole Ø 8.5 mm, 4 pins</i>	30 x 30	B	091359
	10.8 (10.0)	2.0	3.0	1 Kreuz <i>1 cross</i>	30 x 30 R25 - 90°	B	091344
	7.6 (7.3)	3.0	4.0	2 Kreuze <i>2 cross</i>	30 x 60	B	091179
Nut 8 / 10 <i>Slot 8 / 10</i>	8.4 (7.3)	2.0	3.0	4 Stifte <i>4 pins</i>	30 x 45	B	091370
	8.4 (7.3)	2.0	3.0	☁ elektrostatisch entladend, 4 Stifte ☁ electrostatically discharging, 4 pins	30 x 45	B	091370S01

ABDECKKAPPE FÜR RASTERMAß 40 MM

COVER CAP FOR 40 MM MODULAR DIMENSION

Ausführung	Rastermaß 40 mm	Model	40 mm modular dimension
Beschreibung	zum Abdecken der Profilenden	Description	To cover the end of the profile
Material	Kunststoff PA, glasfaserverstärkt	Material	Plastic PA, glass fiber reinforced
Farbe	schwarz	Color	Black
Liefereinheit	100 Stück	Pack Quantity	100 pieces
Extras	☁ elektrostatisch entladend, weitere Größen, weitere Farben auf Anfrage	Specials	☁ electrostatically discharging, other sizes, other colors on request

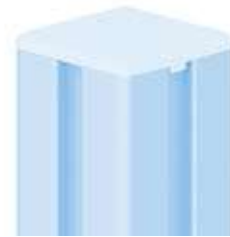
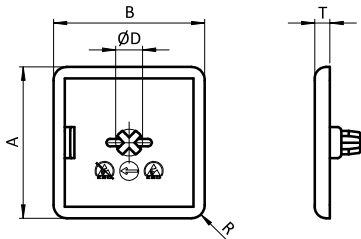

Abdeckkappe Cover Cap	ØD [mm]	R [mm]	T [mm]	Eigenschaft Description	Maße [mm] Dimensions [mm]	Profil Profile	Teil-Nr. Part #
Nut 8 Slot 8	5.1 (5.0)	3.5	4.0	2 Stifte 2 pins	16 x 40	I	091077
	4.4 (4.3)	3.5	4.0	2 Stifte 2 pins	16 x 80	I	091078
	4.3 (4.0)	3.5	4.0	6 Stifte 6 pins	16 x 160	I	091278
	7.1 (6.8)	3.5	4.0	1 Kreuz 1 cross	40 x 40	I	091007
	7.0 (6.8)	4.0	4.0	1 Kreuz 1 cross	40 x 40 45°	I	091048
	7.2 (6.8)	2.5	4.0	1 Kreuz 1 cross	40 x 40 R40 - 90°	I	091045
	6.8 (6.8)	4.0	4.0	neue Ausführung, 1 Kreuz New version, 1 cross	40 x 40 R40 - 90°	I	091320
	6.9 (6.8)	4.0	4.0	2 Kreuze 2 cross	40 x 80	I	091009
	6.9 (6.8)	3.0	4.0	1 Kreuz und 2 Stifte 1 cross and 2 pins	40 x 120	I	091094
	6.9 (6.8)	3.5	4.0	2 Kreuze und 2 Stifte 2 cross and 2 pins	40 x 160	I	091209
	6.8 (6.8)	4.0	4.0	4 Kreuze 4 cross	80 x 80	I	091023
	6.9 (6.8)	3.5	4.0	4 Kreuze 4 cross	80 x 120	I	091095
	6.8 (6.8)	4.0	4.0	8 Stifte 8 pins	80 x 160	I	091118
Nut 10 Slot 10	10.2 (10.0)	3.0	4.0	1 Kreuz 1 cross	40 x 40	B	091046
	10.4 (10.0)	3.0	4.0	☁ elektrostatisch entladend, 1 Kernloch-Zapfen ☁ electrostatically discharging, 1 Pin for core hole	40 x 40 R30 - 90°	B	091345S01
	10.1 (10.0)	3.0	4.0	2 Kreuze 2 cross	40 x 80	B	091137
	10.4 (10.0)	3.0	4.0	4 Kreuze 4 cross	80 x 80	B	091135



ABDECKKAPPE FÜR RASTERMAß 45 MM

COVER CAP FOR 45 MM MODULAR DIMENSION

Ausführung	Rastermaß 45 mm	Model	45 mm modular dimension
Beschreibung	zum Abdecken der Profilenden	Description	To cover the end of the profile
Material	Kunststoff PA, glasfaserverstärkt	Material	Plastic PA, glass fiber reinforced
Farbe	schwarz	Color	Black
Liefereinheit	100 Stück	Pack Quantity	100 pieces
Extras	⚡ elektrostatisch entladend, weitere Größen, weitere Farben auf Anfrage	Specials	⚡ electrostatically discharging, other sizes, other colors on request

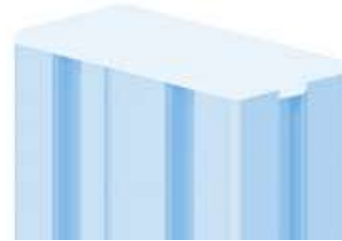
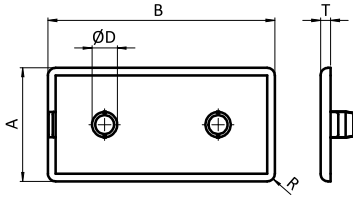

Abdeckkappe <i>Cover Cap</i>	ØD [mm]	R [mm]	T [mm]	Eigenschaft <i>Description</i>	Maße [mm] <i>Dimensions [mm]</i>	Profil <i>Profile</i>	Teil-Nr. <i>Part #</i>
Nut 10 <i>Slot 10</i>	4.0	3.0	4.0	4 Stifte 4 pins	22.5 x 45	B	091002
	10.4 (10.0)	4.0	4.0	1 Kernloch-Zapfen 1 Pin for core hole	45 x 45	B	091011
	4.0	3.0	4.0	mit Loch Ø 17.0 mm, 4 Stifte 4.3 <i>With hole Ø 17.0 mm, 4 pins 4.3</i>	45 x 45	B	091015
	10.8 (10.0)	3.0	4.0	1 Kernloch-Zapfen 1 Pin for core hole	45 x 60	B	091017
	(4.0)	3.0	4.0	mit Loch Ø 18.3 mm, 4 Stifte 4.3 <i>With hole Ø 18.3 mm, 4 pins 4.3</i>	45 x 60	B	091083
	10.4 (10.0)	3.0	4.0	2 Kernloch-Zapfen 2 Pins for core hole	45 x 90	B	091006
	-	3.5	4.0	4 Stützrippen 4 support ribs	90 x 90	B	091024
	15.1	3.0	4.0	neue Ausführung, 4 Stützrippen <i>New version, 4 support ribs</i>	90 x 90	B	091207
	10.2 (10.0)	5.0	4.0	4 Kernloch-Zapfen, 4 Stifte <i>4 Pins for core hole, 4 pins</i>	90 x 90 leicht (superleicht) <i>90 x 90 light (superlight)</i>	B	091030
	15.2	3.0	4.0	8 Stützrippen 8 support ribs	90 x 90 leicht (superleicht) <i>90 x 90 light (superlight)</i>	B	091276



ABDECKKAPPE FÜR KLEMMPROFIL

COVER CAP FOR CLAMP PROFILE

Ausführung	Rastermaß 50 mm	Model	50 mm modular dimension
Beschreibung	zum Abdecken der Profilenden	Description	To cover the end of the profile
Material	Kunststoff PA, glasfaserverstärkt	Material	Plastic PA, glass fiber reinforced
Farbe	schwarz	Color	Black
Liefereinheit	100 Stück	Pack Quantity	100 pieces
Extras	☁ elektrostatisch entladend, weitere Größen, weitere Farben auf Anfrage	Specials	☁ electrostatically discharging, other sizes, other colors on request

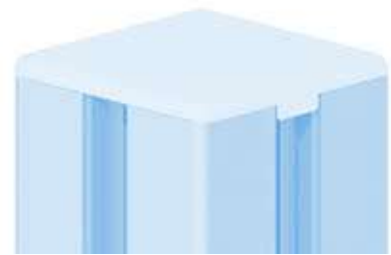
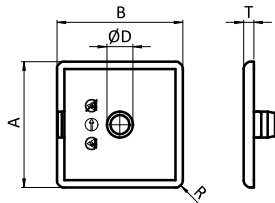

Abdeckkappe für Klemmprofil <i>Cover Cap for Clamp Profile</i>	ØD [mm]	R [mm]	T [mm]	Eigenschaft <i>Description</i>	Maße [mm] <i>Dimensions [mm]</i>	Profil <i>Profile</i>	Teil-Nr. <i>Part #</i>
Nut 10 <i>Slot 10</i>	10.3 (10.0)	3.0	4.0	1 Kernloch-Zapfen <i>1 Pin for core hole</i>	50 x 50	B	091028



ABDECKKAPPE FÜR RASTERMAß 60 MM

COVER CAP FOR 60 MM MODULAR DIMENSION

Ausführung	Rastermaß 60 mm	Model	60 mm modular dimension
Beschreibung	zum Abdecken der Profilenenden	Description	To cover the end of the profile
Material	Kunststoff PA, glasfaserverstärkt	Material	Plastic PA, glass fiber reinforced
Farbe	schwarz	Color	Black
Liefereinheit	100 Stück	Pack Quantity	100 pieces
Extras	☁ elektrostatisch entladend, weitere Größen, weitere Farben auf Anfrage	Specials	☁ electrostatically discharging, other sizes, other colors on request

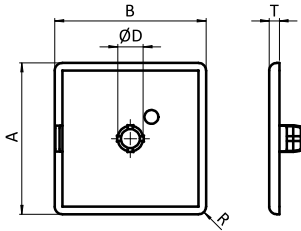

Abdeckkappe <i>Cover Cap</i>	ØD [mm]	R [mm]	T [mm]	Eigenschaft <i>Description</i>	Maße [mm] <i>Dimensions [mm]</i>	Profil <i>Profile</i>	Teil-Nr. <i>Part #</i>
Nut 10 <i>Slot 10</i>	10.6 (10.0)	3.0	4.0	1 Kernloch-Zapfen <i>1 Pin for core hole</i>	60 x 60	B	091021



ABDECKKAPPE FÜR KLEMMPROFIL

COVER CAP FOR CLAMP PROFILE

Ausführung	für Klemmprofil	Model	For clamp profile
Beschreibung	zum Abdecken der Profilen	Description	To cover the end of the profile
Material	Kunststoff PA, glasfaserverstärkt	Material	Plastic PA, glass fiber reinforced
Farbe	schwarz	Color	Black
Liefereinheit	100 Stück	Pack Quantity	100 pieces
Extras	☁ elektrostat. entladend, weitere Größen, weitere Farben auf Anfrage	Specials	☁ electrostatically discharging, other sizes, other colors on request

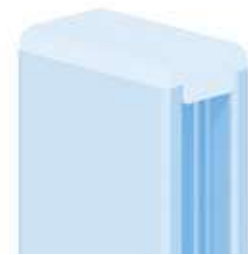
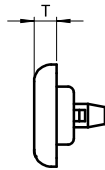
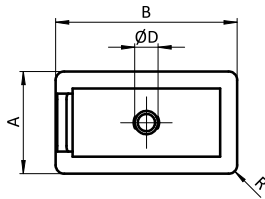

Abdeckkappe für Klemmprofil <i>Cover Cap for Clamp Profile</i>	ØD [mm]	R [mm]	T [mm]	Eigenschaft <i>Description</i>	Maße [mm] <i>Dimensions [mm]</i>	Profil <i>Profile</i>	Teil-Nr. <i>Part #</i>
Nut 10 <i>Slot 10</i>	4.3	1.5	4.0	1 Stift <i>1 pin</i>	18 x 32	I	091049



ABDECKKAPPEN FÜR SCHUTZGITTERPROFILE

COVER CAPS FOR WIRE MESH FRAME PROFILES

Ausführung	Kunststoff PA	Model	Plastic PA
Beschreibung	zum Abdecken der Profilenenden von Schutzgitterprofilen	Description	To seal the end openings of conduit systems
Material	Kunststoff PA, glasfaserverstärkt	Material	Plastic PA, glass fiber reinforced
Farbe	schwarz	Color	Black
Liefereinheit	100 Stück	Pack Quantity	100 pieces
Extras	☁elektrostatisch entladend, weitere Größen, weitere Farben auf Anfrage	Specials	☁electrostatically discharging, other sizes, other colors on request

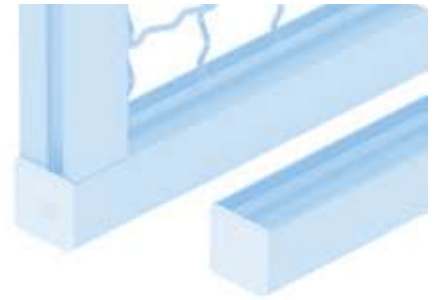
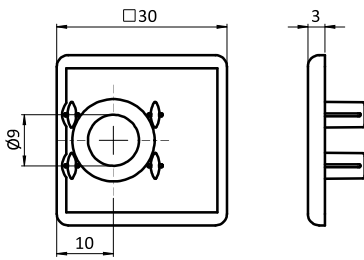

Abdeckkappen für Schutzgitterprofile <i>Cover Caps for Wire Mesh Frame Profiles</i>	ØD [mm]	R [mm]	T [mm]	Eigenschaft <i>Description</i>	Gewicht [g] <i>Weight [g]</i>	Profil <i>Profile</i>	Teil-Nr. <i>Part #</i>
mit Loch <i>With hole</i>		2.0	3.0	4 Stifte <i>4 pins</i>	3.4	B	091337
ohne Loch <i>Without hole</i>		2.0	3.0	4 Stifte <i>4 pins</i>	3.0	B	091337S01

ABDECKKAPPEN ANSCHRAUBBAR

COVER CAPS, SCREW-ON TYPE

Ausführung	Kunststoff PA	Model	Plastic PA
Beschreibung	anschraubbare Abdeckung für Profilen	Description	Bolt-on cover cap for the end of the aluminum profile
Material	Kunststoff PA, glasfaserverstärkt	Material	Plastic PA, glass fiber reinforced
Farbe	schwarz	Color	Black
Befestigung	* mit Senkkopfschrauben M4 x 16, Stahl verzinkt	Fastening	* With flat socket cap screws M4 x 16, zinc plated steel
Liefereinheiten	10 / 50 / 100 Stück	Pack Quantities	10 / 50 / 100 pieces
Extras	⚡ elektrostatisch entladend, weitere Größen, weitere Farben auf Anfrage	Specials	⚡ electrostatically discharging, other sizes, other colors on request
Hinweis	* Bitte separat bestellen: Senkkopfschrauben sind nicht im Lieferumfang der Abdeckkappen enthalten.	Tip	* Please order separately; flat socket cap screws are not included in delivery of the cover caps.

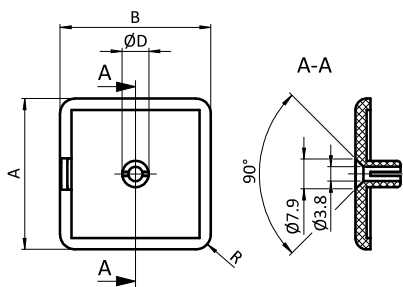

Abdeckkappe Cover Cap	D [mm]	R [mm]	T [mm]	Eigenschaft Description	Liefereinheit Pack Quantity	Gewicht [g] Weight [g]	Schraube Screw	Teil-Nr. Part #
30 x 30	7.0	3.0	4.0	1 Kernloch-Zapfen 1Pin for core hole	100	3.5	1 Schraube 1 screw	091065
30 x 60	7.0	3.0	4.0	2 Kernloch-Zapfen 2 Pins for core hole	100	7.6	2 Schrauben 2 screws	091066
40 x 40	7.0	4.0	4.0	1 Kernloch-Zapfen 1Pin for core hole	100	6.8	1 Schraube 1 screw	091067
40 x 80	7.0	4.0	4.0	2 Kernloch-Zapfen 2 Pins for core hole	50	13.0	2 Schrauben 2 screws	091068
45 x 45	10.5	3.0	4.0	1 Kernloch-Zapfen 1Pin for core hole	100	8.8	1 Schraube 1 screw	091070
45 x 60	10.4	3.0	4.0	1 Kernloch-Zapfen 1Pin for core hole	100	10.3	1 Schraube 1 screw	091072
45 x 90	10.4	3.0	4.0	2 Kernloch-Zapfen 2 Pins for core hole	10	15.0	2 Schrauben 2 screws	091073
60 x 60	10.5	3.0	4.0	1 Kernloch-Zapfen 1Pin for core hole	50	15.0	1 Schraube 1 screw	091071
80 x 80	7.0	4.0	4.0	4 Kernloch-Zapfen 4 Pins for core hole	10	27.4	4 Schrauben 4 screws	091069
90 x 90	10.4	3.0	4.0	4 Kernloch-Zapfen 4 Pins for core hole	10	34.4	4 Schrauben 4 screws	091074
Senkkopfschraube Flat socket cap screw				M4 x 16	100	1.0	*4DIN7991M0416M	



ABDECKKAPPEN ZN ANSCHRAUBBAR

COVER CAPS ZN SCREW-ON TYPE

Ausführung	Zinkdruckguss	Model	Zinc die-cast
Beschreibung	anschraubbare Abdeckung für Profilen	Description	Bolt-on cover cap for the end of the aluminum profiles
Material	Zinkdruckguss	Material	Zinc die-cast
Farbe	schwarz	Color	Black
Befestigung	mit selbstformenden Senkkopfschrauben S7 x 16*	Fastening	With self forming countersunk screws S7 x 16*
Liefereinheit	10 Stück	Pack Quantity	10 pieces
Extras	weitere Größen, weitere Farben auf Anfrage	Specials	Other sizes, other colors on request
Hinweis	* passende selbstformende Senkkopfschraube S7 x 16 siehe Seite 417	Tip	* Compatible self forming countersunk screw see page 417

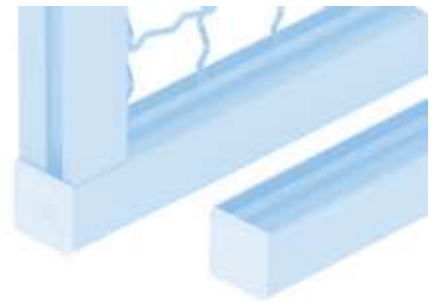
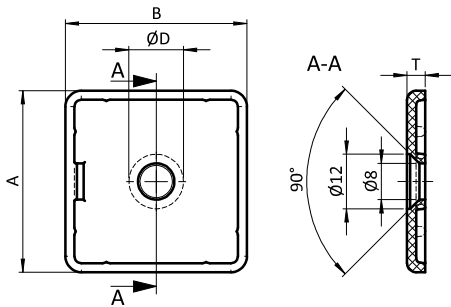

Abdeckkappe Cover Cap	ØD [mm]	R [mm]	T [mm]	Eigenschaft Description	Maße Dimensions	Gewicht [g] Weight [g]	Profil Profile	Teil-Nr. Part #
Nut 8 Slot 8	8.0 (6.8)	3.5	4.0	Bohrung für Senkschraube Bore for countersunk screw	40 x 40	25.5	I	091347
	8.0 (6.8)	3.5	4.0	Bohrung für Senkschraube Bore for countersunk screw	40 x 80	50.0	I	091348
	8.0 (6.8)	3.5	4.0	Bohrung für Senkschraube Bore for countersunk screw	80 x 80	98.0	I	091349



KANAL-ABDECKKAPPEN

CONDUIT CAPS

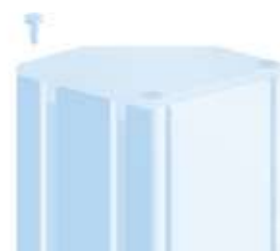
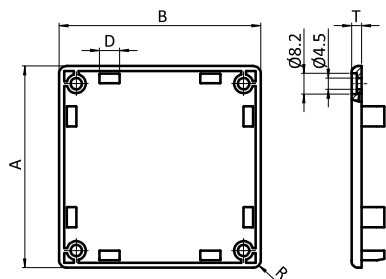

Ausführung	Kunststoff PA	Model	Plastic PA
Beschreibung	zur stirnseitigen Abdeckung von Kanälen; Befestigung mit Schraube M 4	Description	To seal the end openings of conduit systems; Fastening with screw M 4
Material	Kunststoff PA, glasfaserverstärkt	Material	Plastic PA, glass fiber reinforced
Farbe	schwarz	Color	Black
Liefereinheiten	10 / 50 / 100 Stück	Pack Quantities	10 / 50 / 100 pieces
Extras	☁ elektrostatisch entladend, weitere Größen, weitere Farben auf Anfrage	Specials	☁ electrostatically discharging, other sizes, other colors on request



Abdeckkappe Cover Cap	R [mm]	T [mm]	Eigenschaft Description	Größe Size	Liefereinheit Pack Quantity	Gewicht [g] Weight [g]	Profil Profile	Teil-Nr. Part #
4 Bohrungen 4 bore holes	4.0	4.0	4 Stützrippen 4 support ribs	40 x 40	100	8.4	I	091168
	3.0	4.0	6 Stützrippen 6 support ribs	40 x 80	50	14.0	I	091194
	3.0	4.0	8 Stützrippen 8 support ribs	40 x 120	10	21.8	I	091201
	4.0	4.0	10 Stützrippen 10 support ribs	40 x 160	10	29.0	I	091204
	3.0	4.0	8 Stützrippen 8 support ribs	80 x 80	10	28.4	I	091195
45° links; 3 Bohrungen 45° left; 3 bore holes	4.0	4.0	4 Stützrippen 4 support ribs	80 x 80	10	27.0	I	091248L
45° rechts; 3 Bohrungen 45° right; 3 bore holes	4.0	4.0	4 Stützrippen 4 support ribs	80 x 80	10	27.0	I	091248R
4 Bohrungen 4 bore holes	3.0	4.0	10 Stützrippen 10 support ribs	80 x 120	10	46.6	I	091202
	3.0	4.0	12 Stützrippen 12 support ribs	80 x 160	10	59.0	I	091203
20° links; 4 Bohrungen 20° left; 4 bore holes	4.0	4.0	9 Stützrippen 9 support ribs	80 x 160	10	59.0	I	091249L
20° rechts; 4 Bohrungen 20° right; 4 bore holes	4.0	4.0	9 Stützrippen 9 support ribs	80 x 160	10	59.0	I	091249R
4 Bohrungen 4 bore holes	3.0	4.0	12 Stützrippen 12 support ribs	120 x 120	10	72.8	I	091246
	3.0	4.0	14 Stützrippen 14 support ribs	120 x 160	10	93.0	I	091247

ABDECKKAPPE FÜR EINHÄNGEPROFIL

COVER CAP FOR SUSPENSION PROFILE

Ausführung	Kunststoff PA	Model	Plastic PA
Beschreibung	zum Abdecken der Profilenenden von Einhängprofilen	Description	To seal the end openings of suspension profiles
Material	Kunststoff PA, kohlefaserverstärkt	Material	Plastic PA, carbon fiber reinforced
Farbe	schwarz	Color	Black
Liefereinheit	20 Stück	Pack Quantity	20 pieces
Extras	nicht  elektrostatisch entladende Ausführung auf Anfrage	Specials	not  electrostatically discharging version on request

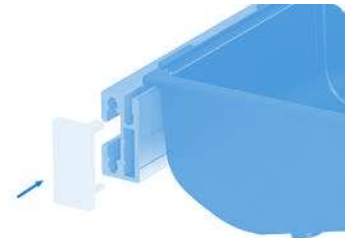
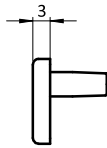
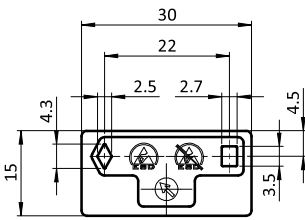

Abdeckkappe für Einhängprofil
 Cover Cap for Suspension Profile

Gewicht [g]
 Weight [g]

Profil
 Profile

Teil-Nr.
 Part #

elektrostatisch entladend  <i>electrostatically discharging</i>	1.6	B	091374S01
--	-----	---	------------------



ABDECKKAPPEN

COVER CAPS

Ausführung	Kunststoff PA	Model	Plastic PA
Beschreibung	zum Abdecken der Profilenden, passend für Aluminiumabdeckprofilstücke	Description	To cover the end of the profile, suitable for pieces of aluminum cover profiles
Material	Kunststoff PA, glasfaserverstärkt	Material	Plastic PA, glass fiber reinforced
Farbe	schwarz	Color	Black
Liefereinheit	100 Stück	Pack Quantity	100 pieces
Extras	☁ elektrostatisch entladend, weitere Größen, weitere Farben auf Anfrage	Specials	☁ electrostatically discharging, other sizes, other colors on request

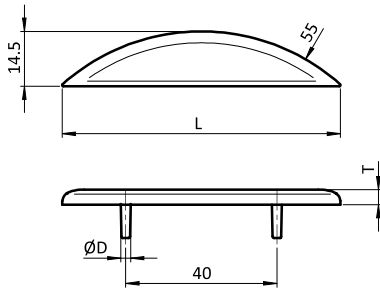

Abdeckkappe Cover Cap	L [mm]	Maße [mm] Dimensions [mm]	Gewicht [g] Weight [g]	Profil Profile	Teil-Nr. Part #
	74	R80	2.0	I	091333



CLIP 8

CLIP 8

Ausführung	Nut 8	Model	Slot 8
Beschreibung	zur Befestigung von Aluminiumabdeckprofilstücken auf Aluminiumprofil Nut 8; empfohlene Anzahl: 5 Stück auf 1 m	Description	To fix pieces of aluminum cover profiles to aluminum profiles, slot 8; recommended quantity: 5 pcs. per 1 m
Material	Federstahl	Material	Spring steel
Liefereinheit	10 Stück	Pack Quantity	10 pieces

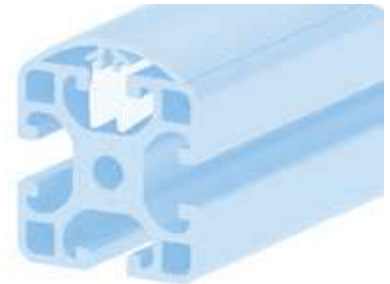
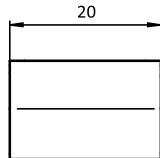
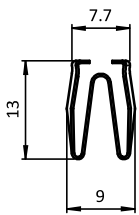

Clip 8	Gewicht [g] Weight [g]	Profil Profile	Teil-Nr. Part #
	2.6	I	092311N08